

ΩMEGA

RETAINING WALL SYSTEM

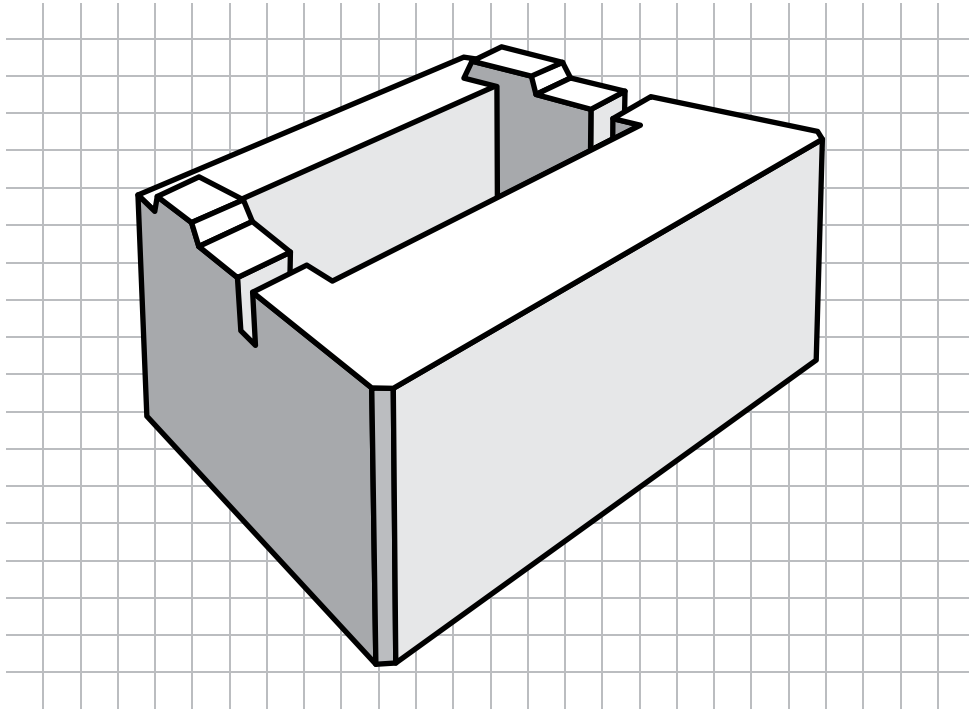

Installation Instructions & Technical Information

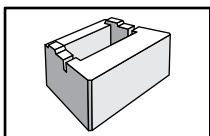

Omega Retaining Wall Straight Face Unit

Dimensions: 8" H x 18" W x 12" D
Face Area: 1.0 ft²
Weight: 78.26 lbs

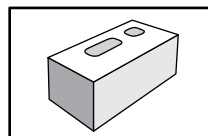

Phillips Universal Retaining Wall Corner Unit

Dimensions: 8" H x 18" W x 9" D
Face Area: 1.0 ft² / 0.5 ft²
Weight: 86.0 lbs

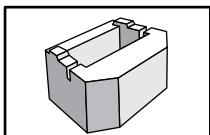

Omega Retaining Wall Beveled Face Unit

Dimensions: 8" H x 18" W x 12" D
Face Area: ~1.0 ft²
Weight: 74.18 lbs

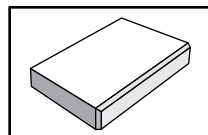

Phillips Universal Retaining Wall Cap Unit

Dimensions: 3" H x 18" W x 12" D
Face Area: 0.375 ft²
Weight: 49.0 lbs

BASIC INSTALLATION INSTRUCTIONS

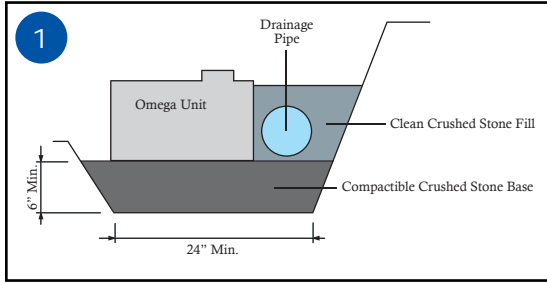

Omega Retaining Wall should be placed on a properly prepared base of compactible crushed stone. Do not use Pea Gravel. Dig a trench 24" wide and deep enough to allow for 6" of base material plus, an additional 1" for every 6" of wall to be exposed above grade. For acceptable results, base must be properly leveled and compacted. Drainage pipe should be placed at rear base of first course.

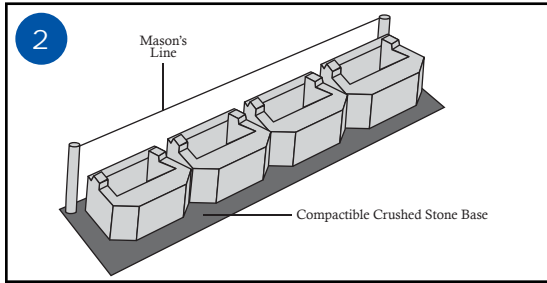

Place first unit at the lowest level of elevation. Each unit must be leveled from side to side as well as front to back. Blocks must be installed with the tabs facing up. To aid in keeping the wall straight, place a mason's line along the back side. Backfill each course and fill block voids with clean crushed stone. Sweep tops of units before installing next course.

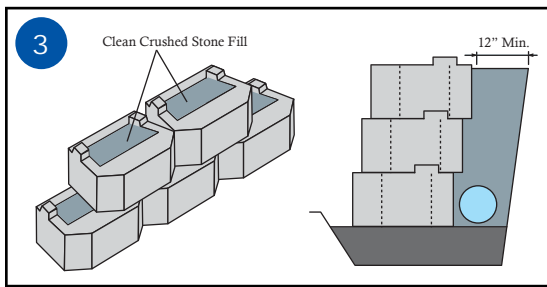

Add additional rows of Omega Block by placing the center of the units over the intersection of two units from the previous row, making sure to pull the block forward so that the back of the block stops against the tabs of the two units below. This will create the system's native 1" setback. Fill block voids and backfill a minimum of 12" behind wall with clean crushed stone to allow proper drainage flow, preventing any possible structural or drainage problems.

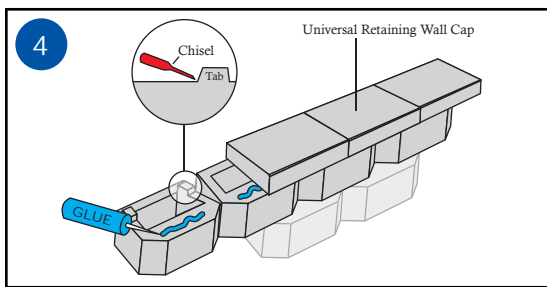

Once all courses of Omega block are installed to your satisfaction, complete the installation by placing Universal Retaining Wall Caps over the top course of Omega block. When placing caps, knock tabs off of top Omega course and secure caps with a suitable concrete or retaining wall adhesive. Caps may be installed flush to block, with an overhang, or set back to match the set back of the Omega block.

STEPPED WALLS

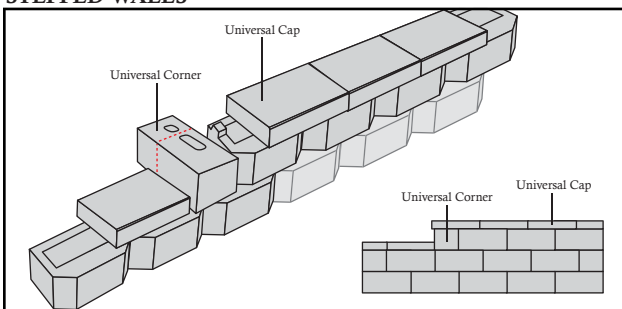

The Phillips Universal Retaining Wall Corner can be used to create both right and left hand corners for the Omega Retaining Wall System by simply flipping it in the appropriate direction. The corner block may be tailored to many different applications by splitting it at any of the designated points.

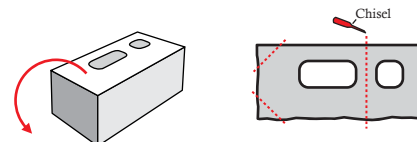

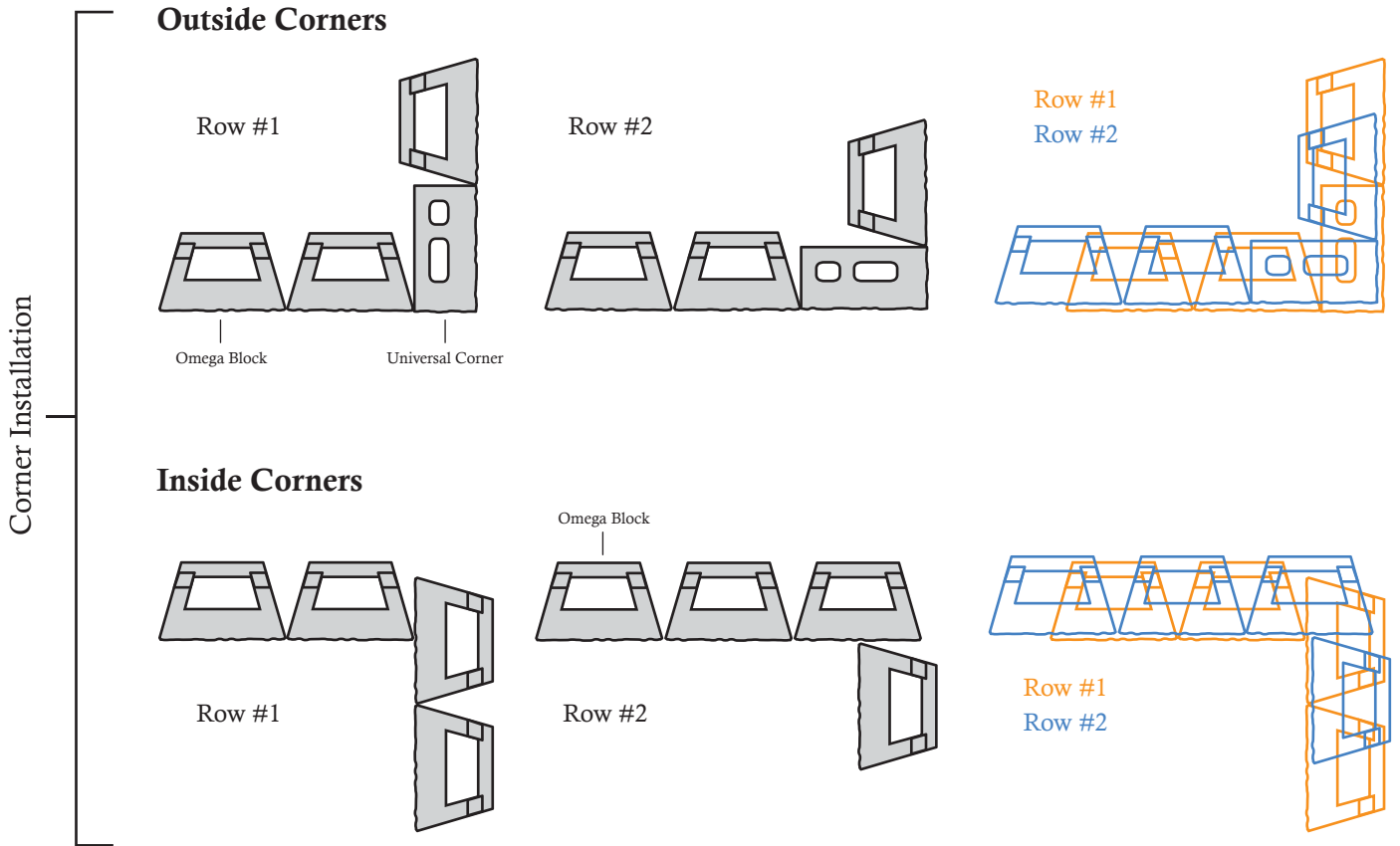

Convex Curve

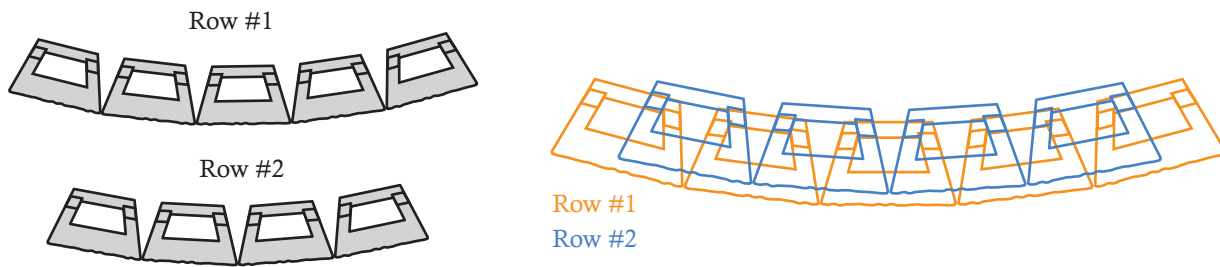

Concave Curve

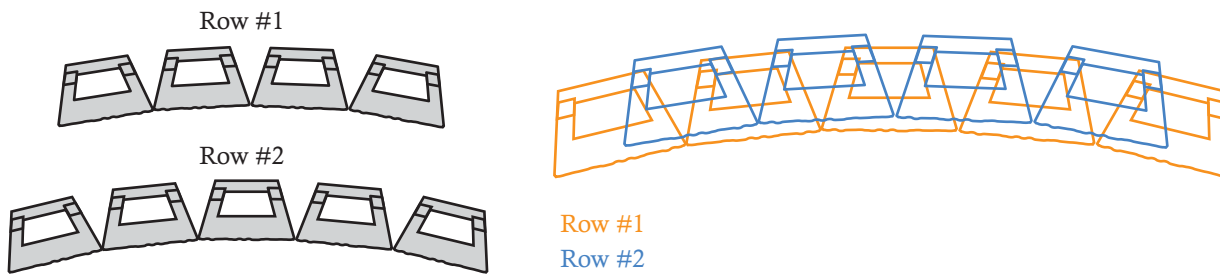

Curve Installation